

PX707

DMX512/RDM Constant Current Decoder

Feature

- Meet DMX512/1990, RDM/2009 international standard protocol
- 4 output channels, output current 200 to 1600mA per channel
- Can easily set DMX address by button
- Can easily set output current each channel
- With the light color selected mechanism, and be able to control the light with 1~4 colors
- 8 Bit /16 Bit level brightness, full-color control
- For customer setup and use easily, the default address code is 1
- Address setting become brightness setting when DMX signal isn't connect
- Suitable for buildings, hotels, KTV, home and other places
- Flicker free



Technical Parameter

Channels	4 channels
Input Voltage	12-50V DC
Output Voltage	1-42V DC
Output Current	200 to 1600mA per channel
Output Power	67W / CH MAX. 240W
Protection	Short-circuit protect, Over current protect, Over temp protect
Dimension	135(L)×69(W)×36(H) mm
N.G.	352g
Operation Temperature	-20 - 50 °C

Product Size

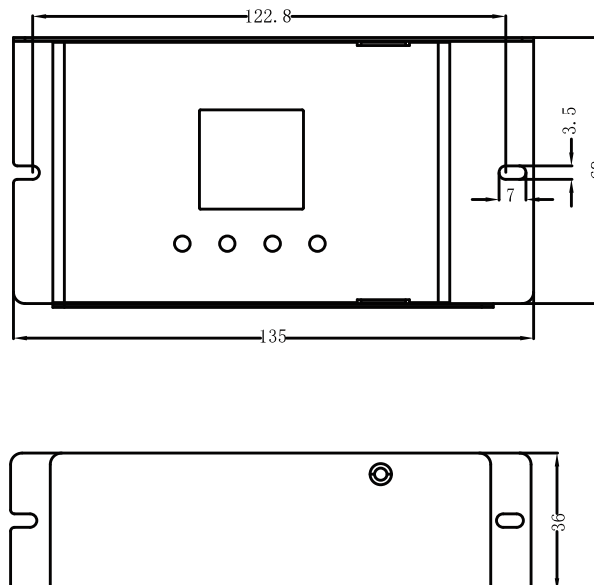

Interface Description

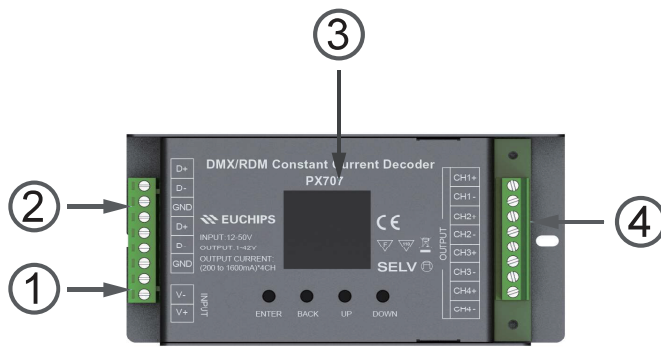

- (1) Power input interface
- (2) DMX/RDM Signal input and output
- (3) OLED Screen
- (4) Output interface

OLED Screen Description

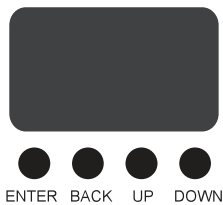

Button Name	Function
Enter	Enter Button (focus on the option menu pointed by the cursor and enter the state of this option menu.
BACK	Back Button, return to the previous menu exit the state of this option
Up	Move the cursor up, change the state of the option
Down	Move the cursor down, change the state of the option

The product restores the default initial page which shows the current parameter information and working status when power on again. Please press "ENTER" to homepage. If there is no operation in 1 minute, the OLED screen will restore the initial page.

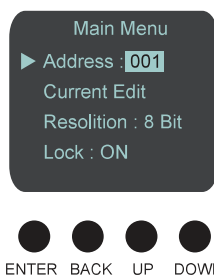
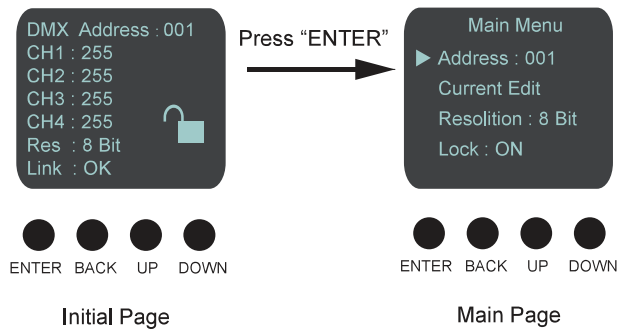

DMX Address setting

Press "up" or "down" key to set DMX Address

Address : 1-511 adjustable

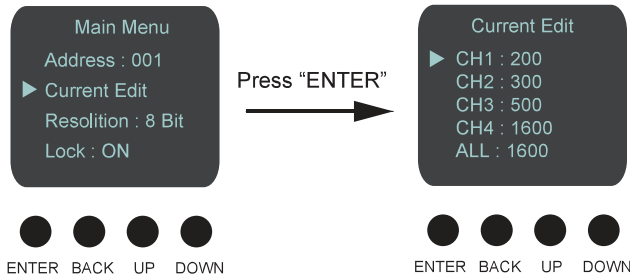

Current Edit

- CH1 : 200-1600mA adjustable
- CH2 : 200-1600mA adjustable
- CH3 : 200-1600mA adjustable
- CH4 : 200-1600mA adjustable
- ALL : 200-1600mA adjustable



Resolution setting

Press "up" or "down" key to set resolution

- Resolution : 8Bit
- 16Bit

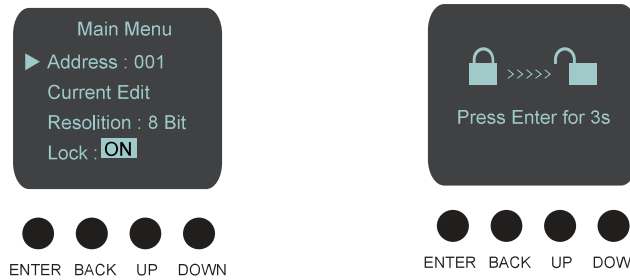

Lock : ON
Screen will be locked if unmaned operation for 1 min , press "Enter" key for 3s to unlock

Wiring Diagram

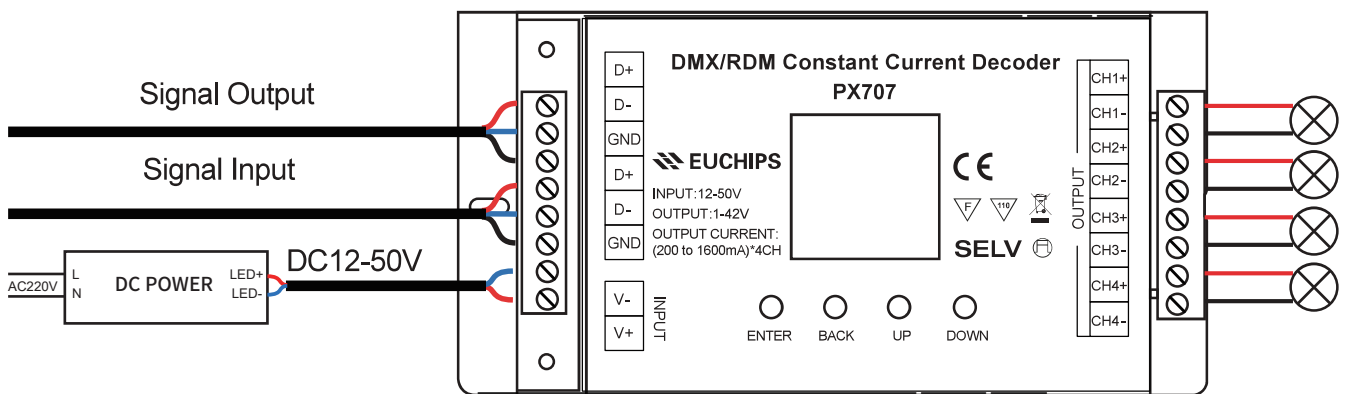

Installation Notes

1. This controller is a buck type, not a boost type. The input voltage is supplied by a constant voltage power supply with appropriate power. The output voltage of the constant voltage power supply should be in the range of 12 - 50V, such as 12V, 24V, 36V and 48V. At the same time, the voltage of this constant voltage power supply should be at least 6V higher than the service voltage of the lamp connected to the controller's output terminal. If the service voltage of the lamp is 9V, then the constant voltage power supply should be 24V, 36V or 48V, such as 36V, the constant voltage power supply should be 48V.
2. If the wattage of the lamp is very low (for example 1W), the input voltage must be selected 12V , and the output current should match the working current corresponding to the lamp.
3. Each channel of "V+" can only provide a maximum current of 1.6A. If the lamps are connected in a common anode mode, we recommended to connect the four groups of " V+" of the decoder together .
4. Do not overload.
5. Installed in a ventilated and dry environment , should ensure that all wiring is correct before electricity.
6. Before commissioning of the power.
7. If failure, do not secretly maintenance, please contact the supplie.