

PX3204-OLED DMX512 Decoder&Master



32 channels output, the maximum current of 4A /ch for RGBW decoder, up to 3072W
OLED Screen and touch button, more convenient operation
Can be used as stand alone DMX Master controller
8 bit / 16 bit resolution optional
Multiple dimming curve: (0.1~9.9), liner, log

Summary

Welcome to use PX series DMX512/RDM decoder & driver. PX series adopt the advanced micro-computer control technology and converted the DMX512,RDM/2009 digital signal widely used in international to the PWM control signal, 1~32 channels output for option and each channel able to achieve 256 or 65536 gradations of controlling, and also it can be used as the connector of PC digital light controller and analog light modulator. It is mainly used for the controlling of buildings & lights applied LED.

Product Features

- 32 channels output, the maximum current of 4A /ch for RGBW decoder, up to 3072W
- Can be used as stand alone DMX Master controller
- OLED Screen and touch button, more convenient operation
- 27 sense modes built-in, with speed and brightness adjust function
- 4 kinds of optional: DIM, CT, RGB,RGBW
- 3 kinds of DMX ports: Green terminal, RJ45, XLR-5
- Short-circuit protection, overload protection, over-temperature protection
- Fast self-testing function
- 8 bit / 16 bit resolution optional (master mode support 8bit only)
- Multiple dimming curve: (0.1~9.9), liner, log
- Meets DMX512/1990,RDM /2009 protocol
- Supported RDM parameters:
 - DISC_UNIQUE_BRANCH
 - DISC_MUTE
 - DISC_UN_MUTE
 - DEVICE_INFO
 - SOFTWARE_VERSION_LABEL
 - DMX512/RDM_START_ADDRESS
 - IDENTIFY_DEVICE
 - MANUFACTURER_LABEL
 - SUPPORTED_PARAMETERS

Technical Parameters

Model :	PX3204-OLED
Input Signal :	DMX512 1990/RDM 2009
Input Voltage :	12~24V
Output Voltage :	12~24V
Output Current :	4A*32CH MAX. 128A
Output Power :	(0~48W...96W)*32CH MAX. 3072W
Control Mode :	DIM/CT/RGB/RGBW
Dimming Curve :	0.1~9.9/Liner/Log
Grey Level :	8Bit (256 levels) / 16Bit (65536 levels)
Protection :	Short-Circuit / Over Load / Over Temperature
Dimension :	302*93*36 mm (L * W * H)
Packing Size :	332*104*42 mm (L * W * H)
G.W. :	846 g
Operation Temperature :	- 20 - 50 C
Relative humidity :	20% - 90% RH

Dimension(mm)

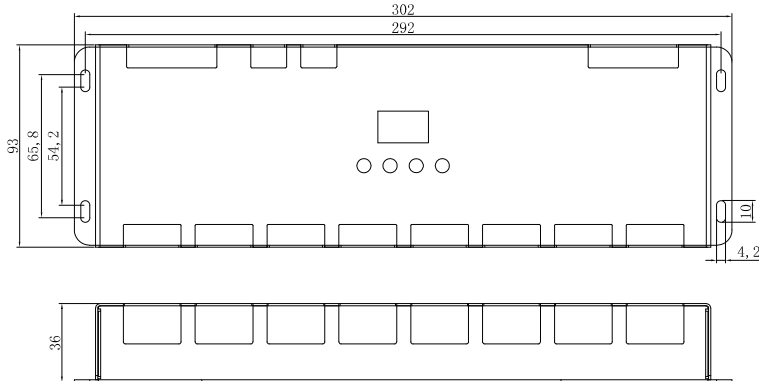

Interface Description

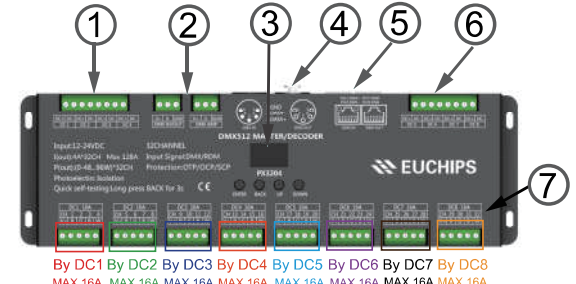

- (1) Power input interface (DC1, DC2, DC3, DC4)
- (2) Green terminal signal input and output
- (3) OLED screen
- (4) XLR-5 signal input and output
- (5) RJ45 signal input and output
- (6) Power input interface (DC5, DC6, DC7, DC8)
- (7) Green terminal LED Lamps connection

OLED Screen Description

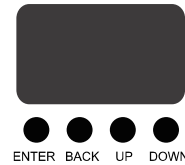

Button Name	Function
Enter	Enter Button (focus on the option menu pointed by the cursor and enter the state of this option menu.
BACK	Back Button, return to the previous menu: exit the state of this option
Up	Move the cursor up, change the state of the option
Down	Move the cursor down: change the state of the option

The product restores the default initial page which shows the current parameter information and working status when power on again. Please press "ENTER" to homepage. If there is no operation in 1 minute, the OLED screen will restore the initial page.

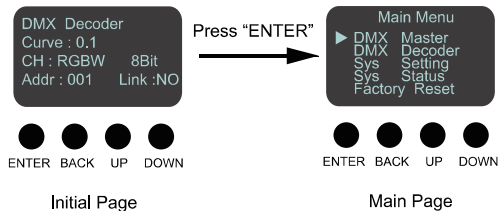

DMX Master

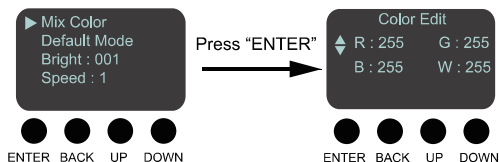

Mix color

RGBW Brightness setting

R : 0-255 adjustable

G : 0-255 adjustable

B : 0-255 adjustable

W : 0-255 adjustable

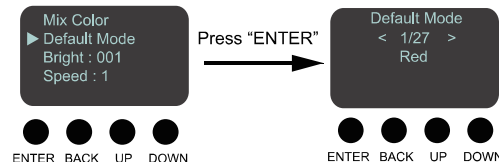

Default Mode

(RGB/RGBW)

Built-in mode : 1-27 modes for option, all 27 modes

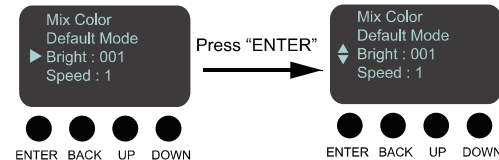

Bright

Press "up" or "down" key

0-255 adjustable

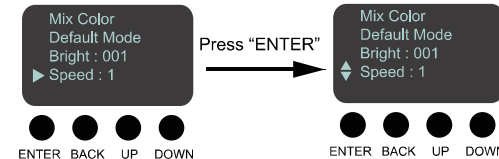

Speed

Press "up" or "down" key

1-100 adjustable

Default Mode (RGB/RGBW)

NO.	Mode	NO.	Mode
1	Red	15	GB Ramp
2	Green	16	RGB Ramp
3	Blue	17	ALL Ramp
4	Yellow	18	RG_Gradient
5	Cyan	19	RB_Gradient
6	Purple	20	GB_Gradient
7	White	21	RGB_Gradient
8	RG Jump	22	ALL_Gradient
9	RB Jump	23	RG_Chase
10	GB Jump	24	RB_Chase
11	RGB Jump	25	GB_Chase
12	ALL Jump	26	RGB_Chase
13	RG Ramp	27	ALL_Chase
14	RB Ramp		

Default Mode (CT)

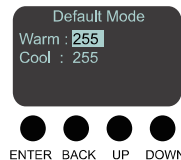

CT Brightness setting

Press "up" or "down" key

Warm : 0-255 adjustable

Cool : 0-255 adjustable

Default Mode (DIM)

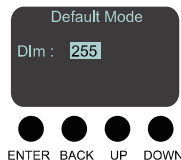

DIM Brightness setting

Press "up" or "down" key

Dim : 0-255 adjustable

DMX Decord

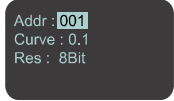

DMX Address setting

Press "up" or "down" key to set DMX Address

Address : 1-511 adjustable

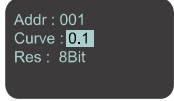

Dimming Curve setting

Press "up" or "down" key to set dimming curve

Curve : 0.1~9.9
Linear
Log

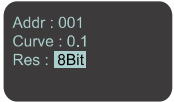

Resolution setting

Press "up" or "down" key to set resolution

Resolution : 8Bit
16Bit



Sys Setting



Output setting

Press "up" or "down" key to set output channel

CH : DIM
CT
RGB
RGBW

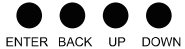

Lock : ON
Screen will be locked if unmaned operation for 1 min , press "Enter" key for 3s to unlock

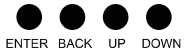

Sys Status



OTP/OCP/SCP Status

When you use DMX decoders after the wiring completed, you can check the short circuit, over current, over load problems in this page once the fault occurs and the "OK" will switch to "Warning" on the screen.



Factory Reset

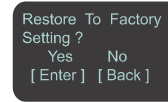

Self -testing

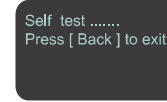

Quick self-testing

Press "BACK" for 3s

Wiring Diagram

Connecting LED lights:

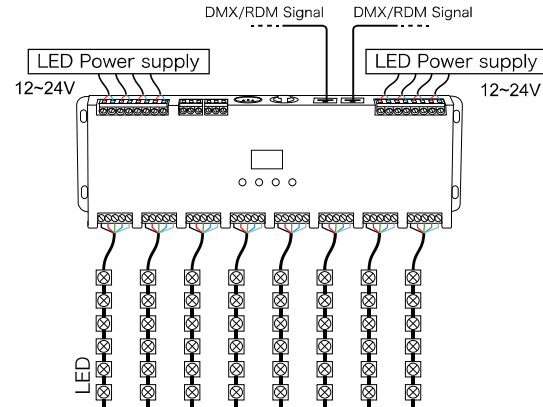

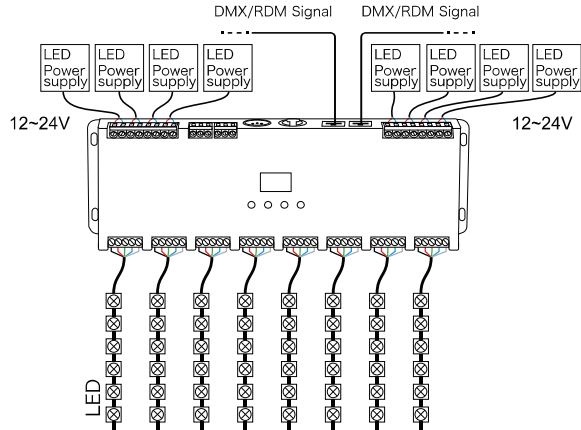

PC



DMX主控

PX0508-OLED is equipped with 3 types DMX terminals for users' selection. The following diagram takes RJ45 as an example, same connecting method for XLR-5, Green terminal.

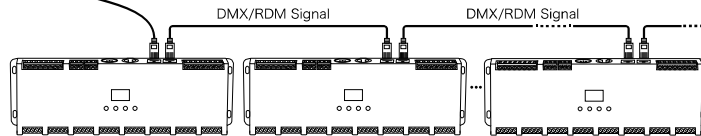

An amplifier is needed when more than 32 decoders are connected, signal amplification should not be more than 5 times continuously.

If the recoil effect occurs because of longer signal line or bad line quality, please try to connect 0.25W 90-120Ω terminal resistor at the end of each line.

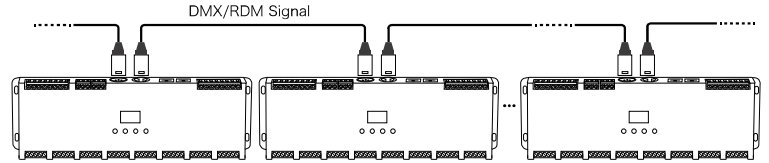

XLR-5 Connected in parallel

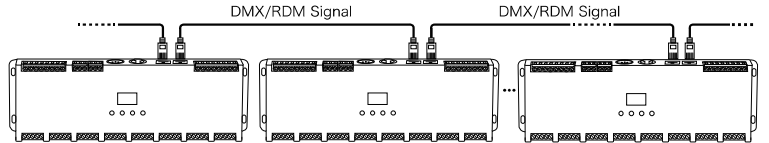

RJ45 Connected in parallel

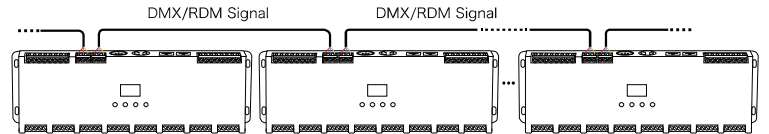

Green terminal Connected in parallel

Address setting table

Mode	DIM	CT	RGB	RGBW	RGBY	
Address Quantity	1	2	3	4	5	
Resolution	8bit	8bit	8bit	8bit	8bit	
Channel	1	001	001	001	001	001
	2	001	002	002	002	002
	3	001	001	003	003	003
	4	001	002	003	004	004
	5	001	002	003	004	005

Mode	DIM	CT	RGB	RGBW	RGBY	
Address Quantity	2	4	6	8	10	
Resolution	16bit	16bit	16bit	16bit	16bit	
Channel	1	001 002	001 002	001 002	001 002	001 002
	2	001 002	003 004	003 004	003 004	003 004
	3	001 002	001 002	005 006	005 006	005 006
	4	001 002	003 004	005 006	007 008	007 008
	5	001 002	003 004	005 006	007 008	009 010