

EULP15AT-1WPC-WB

Summary

EULP15AT-1WPC-WB is a constant current mode output LED driver. The driver supports leading edge (Triac) and trailing edge (ELV) dimmer, 0-10V to achieve a smooth dimming effect.

Product Features

- Single channel output, output current can be selected by software
- Compatible with TRIAC (forward-phase or leading-edge), ELV (reverse-phase or trailing-edge) and 0-10 V dimmers
- TRIAC and ELV dimming at 120 Vac only
- Class 2 power supply
- Protections: Over load, Over Voltage and short-circuit
- Suitable for indoor LED lighting application

Application



Down Light



Flicker free



0-10V



TRIAC/ELV



Programming Current



Short Circuit Protection



Over Load Protection



Over Voltage Protection



Technical Parameters

Model	EULP15AT-1WPC-WB	
Input	Efficiency	≥81%@120VAC, ≥80%@277VAC, Full load
	Frequency	50-60Hz
	Voltage	120VAC-277VAC
	PF	0.98@120VAC, 0.9@277VAC, Full load
	THD(full load)	≤10%@120VAC, ≤15%@277VAC, Full load
	Current	0.17Amax@120VAC, 0.1A@277VAC
	Inrush Current	Cold start, 6A@120VAC 100us, 11A@277VAC 100us
	Standby Power	≤2W
	No load power	≤2W, ≤2.2W@277VAC
	Turn on delay Time	≤0.75s (When the light begins to shine)
Output	Current	150-400mA (Default current: 250mA)
	Voltage	9-50V *(Triac dimming above 20V has better dimming effect)
	Power	15W max *(Triac dimming with a load of 3W or more has better dimming effect)
	Channel	1
	No load output voltage	59V Max
	Current Accuracy	±5% (*150mA ±7%)
	LF current ripple(<120Hz)	<3%
Protection	Over Voltage	Reduce current protection, restore normal operation after troubleshooting
	Over load	Reduce current protection, restore normal operation after troubleshooting
	Short circuit	No output, self recovery after removing the fault
Safety & EMC	Surge	L-N:2.5KV (ANSI/IEEE C62.41.1-2002 & c62.41.2-2002 category A, 2.5 kV ringwave)
	Withstand Voltage	I/P-O/P: 2000Vac/1min/<5mA, I/P-PG:1500Vac/1min/<5mA, O/P-PG: 500Vac/1min/<5mA, O/P-DIM(Signal port):500Vac/1min/<5mA
	Safety standards	UL8750/UL1310/CSA25013,CSA class P
	EMI Eission	EN55015,EN61000-3-2 Class C,IEC61000-3-3
	EMC Immunity	FCC class B(120V)/class A(277V)
Function	Dimming type	0-10V, TRIAC/ELV(@120VAC 60Hz)
	Dimming range	1%-100%
	Dimming curve	0-10V: (Linearity) TRIAC/ELV: (Linearity)
	Flicker	Flicker free
Others	Working temp.	(-20-+50) °C [-4°F-122°F]
	Relative humidity	20-90% RH
	tc	70°C [158°F]
	Lifetime	50,000h@tc:70°C[158°F]
	Warranty Condition	5 years
	Switch cycle	>25,000 times
	IP rating	IP20
	Material	Metal
	Dimension	105*28*25mm (4.13*1.1*0.98 Inch)(L*W*H)
Pack Information	N.W: 150g(0.33 lb)±5%/PCS; 75 PCS/ Carton; 11.75kg(25.9 lb)±5%/Carton; Carton Size: 358x203x184mm(14.1*8.0*7.24 Inch)(L*W*H)	

Dimension(mm)

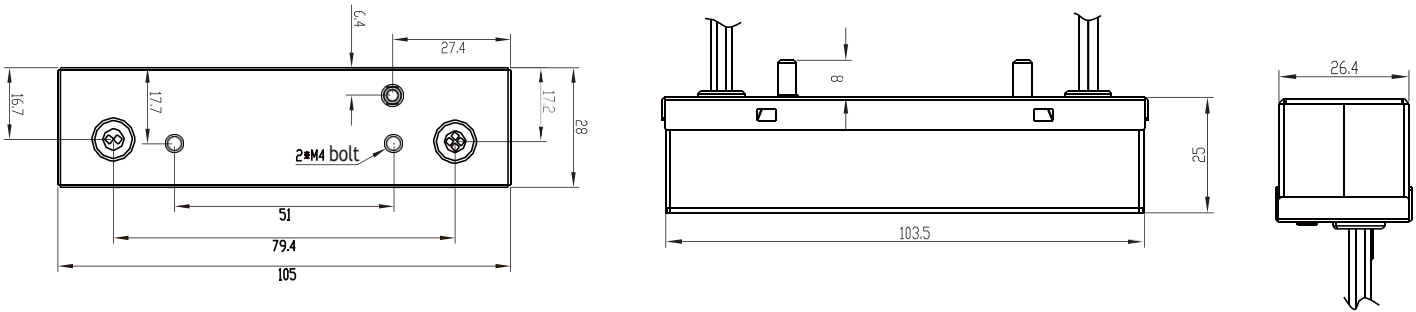

Wiring Diagram

Metal case

All material to be ROHs compliant to Directive 2002/95/EC

Wires to be Stranded with UL approval

Input: Black & White: 200mm , 18AWG

Output: Red & Blue: 200mm , 18AWG

Dimming: Purple & Pink:200mm , 20AWG

Mode switching

To 0-10V Mode:Set the dimming voltage to $\leq 5V$ and hold for 5 seconds.

To Triac Mode:Turn the Triac knob to the middle position and hold for 5 seconds.

Note: The mode remains active after switching. Repeat the steps to change modes.

0-10V Wiring

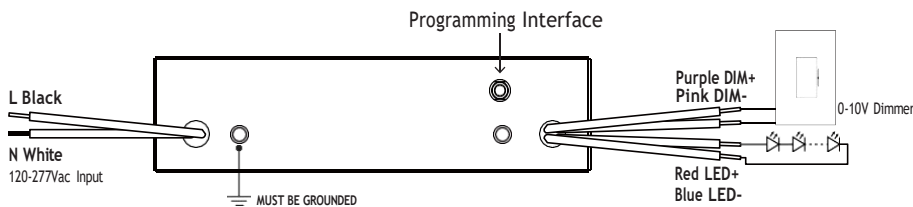

Triac/ELV Wiring

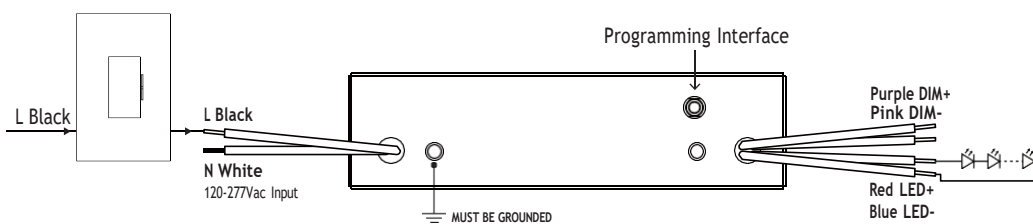

Configurable functions

- Data log reading: SKU, serial number, batch number, FW revision version
- Output current regulation (factory default: 250mA)
- Dimming depth editing (factory default: see technical parameter table, editable range 10% Max)
- Dimming curve editing. Built in linear and logarithmic fixed curves, can be directly selected for use. At the same time, it has built-in custom curves and supports editing curves.
- Support parameter copying/replication and batch editing.

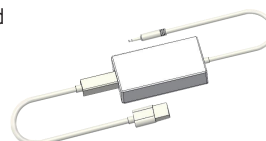

EU-PROG Programming connector

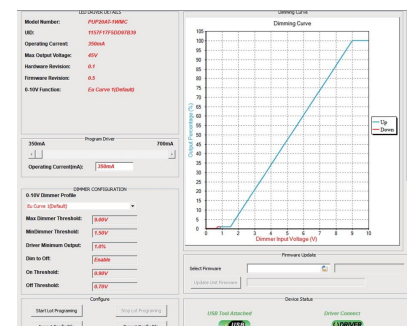

Interface

0-10V Dimming Curve

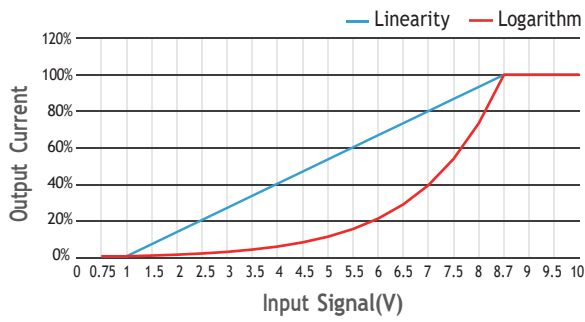

Triac Dimming Curve

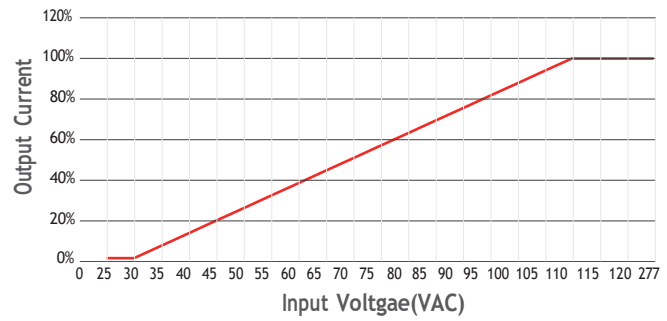

PF vs Load Curve

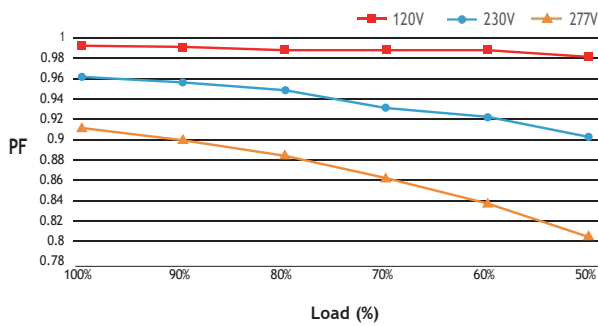

THD vs Load Curve

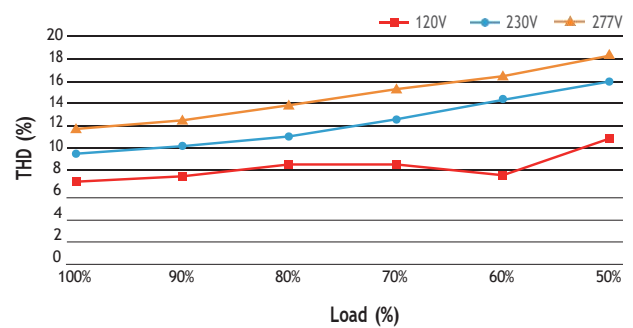

Efficiency vs Load Curve

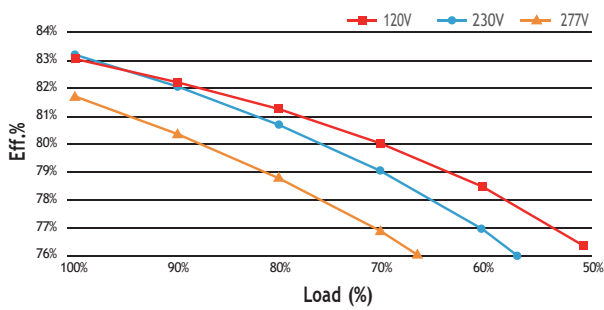

Derating Curve

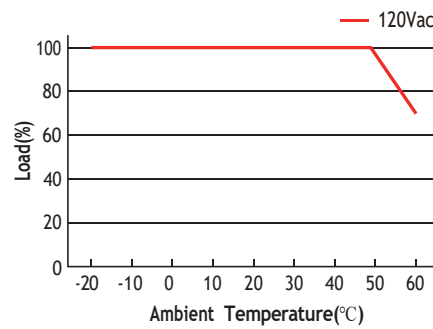

Life-time vs. case temperature

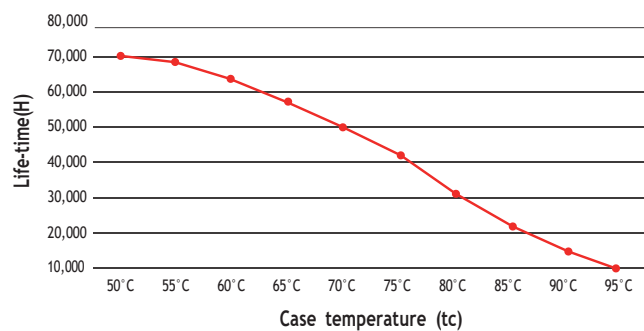

The life-time of the led driver is shown in the figure above (calculated based on the 90% survival rate).

The relation of tc to temperature depends also on the luminaire design.

Work Window

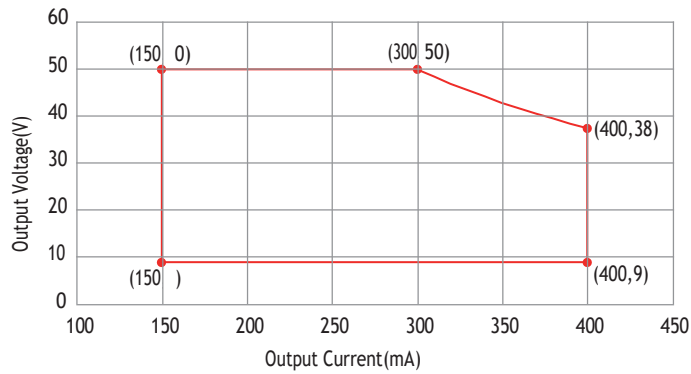

*(Triac dimming above 20V has better dimming effect)

Adjustable output current

The current can be adjusted through a programmer, with a range of 150-400mA and a minimum adjustment current of 1mA. Example: 150mA/151mA/152mA--400mA.

The table provides examples of partial currents:

Output Current	150mA	200mA	250mA	300mA	350mA	400mA
Output Voltage	9-50VDC	9-50VDC	9-50VDC	9-50VDC	9-43VDC	9-38VDC
Output Power	7.5W	10W	12.5W	15W	15W	15W

Max. quantity of drivers per miniature circuit breaker

Specification item	Value	Value	Condition
Inrush current I_{peak}	6A (120V)	11A (277V)	Input Voltage 120V/277V
Inrush current T_{width}	100us (120V)	100us (277V)	Input Voltage 120V/277V, measured to 50% I_{peak}

MCB	Input Voltage 120V Drivers	Input Voltage 277V Drivers	MCB	Input Voltage 120V Drivers	Input Voltage 277V Drivers
B10	58pcs	77pcs	C10	58pcs	100pcs
B13	76pcs	101pcs	C13	76pcs	130pcs
B16	94pcs	124pcs	C16	94pcs	160pcs
B20	117pcs	155pcs	C20	117pcs	200pcs
			D16	94pcs	160pcs

Installation Precautions

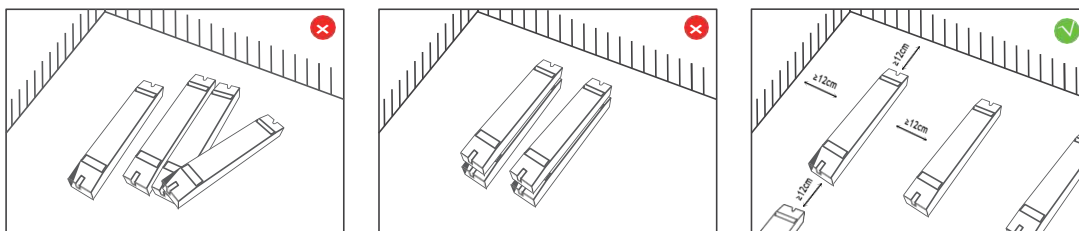

Please do not stack the products. The distance between two products should be >12cm so as not to affect heat dissipation and the lifespan of the products.

Cautions

This product must be installed and adjusted by a qualified professional.		
1	Confirmation of installation conditions	<ul style="list-style-type: none"> · Waterproof and Protection: Install in a suitable location according to the waterproof and protection requirements of the power supply. Products without waterproof function should be protected from direct sunlight and rain. When installing outdoors, please use a waterproof box for protection. · Heat dissipation requirements: The drive power supply should avoid exposure to high temperature environments. Please ensure that the working environment temperature is within the recommended range. To ensure proper heat dissipation of the drive power supply, a well ventilated area should be selected for installation. Good heat dissipation conditions can help extend product lifespan.
2	Power check	<ul style="list-style-type: none"> · Before use, check the product parameters and confirm that the output voltage and current of the LED power supply meet the requirements
3	Safe wiring	<ul style="list-style-type: none"> · Use cables that meet the specifications to ensure that the cross-section of the wire matches the requirements of the driving power supply. Solid cables typically measuring 0.75-2.5 mm², (Please refer to the silk screen printing or wiring diagram in the instruction manual for specific wire diameter requirements). · If the power supply (metal casing) is installed on a grounded lighting component or equipment, the power supply needs to be grounded.
4	Wiring confirmation	<ul style="list-style-type: none"> · Before power on debugging, ensure that the wiring is secure and avoid poor contact to prevent unstable current or equipment damage.
5	Repair suggestions	<ul style="list-style-type: none"> · If the product malfunctions, please do not repair it without authorization. If you have any questions, please contact the supplier or sales team for assistance.

※ The contents of this manual are updated without prior notice. If the function of the product you are using is inconsistent with the instructions, the function of the product shall prevail. Please contact us if you have any questions .

Warranty Agreement

1. Warranty periods from the date of delivery : 5 years.
2. Free repair or replacement services for quality problems are provided within warranty periods.

Warranty exclusions below:

The following situations are not covered by the free warranty or replacement service:

1. Exceeding the warranty period.
2. Damage caused by human factors such as high voltage, overload, and improper operation.
3. The appearance of the product is severely damaged or deformed.
4. Wear or aging that occurs during normal use of the product.
5. Damage caused by natural disasters or force majeure factors.
6. The quality inspection label of the product is damaged (QC PASS).
7. No contract or valid invoice proof signed with EUCHIPS has been provided.

※Remedial measures: Repair or replacement is the only remedy provided by Oches to the customer, and Oches shall not be liable for incidental damages arising from repair or replacement, unless within the scope of applicable law.

※Adjustment of Warranty Terms: EUCHIPS reserves the right to modify or adjust the warranty terms, which shall be published in writin