

## PX708

### Feature

- Meet DMX512/1990, RDM/2009 international standard protocol
- 4 output channels, output current 350/500/700mA per channel
- Can easily set DMX address by button
- With the light color selected mechanism, and be able to control the light with 1~4 colors
- For customer setup and use easily, the default address code is 1

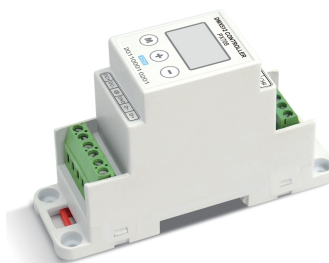

### Technical Parameter

Channels	4 channels
Input Voltage	12-48V DC
Output Voltage	1-42V DC
Output Current	350/500/700mA per channel
Output Power	28W / CH MAX. 110W
Protection	Short-circuit protect, Over current protect, Over temp protect
Dimension	112(L)×35(W)×67(H) mm
N.G.	90g
Operation Temperature	-30 - 50°C

### Product Size

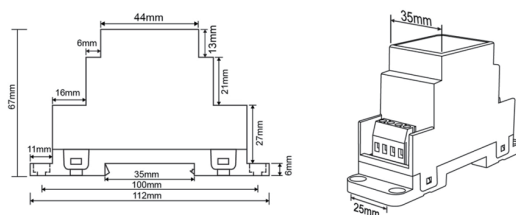

### Power input interface:

DC 12-48V input, supply power for decoder and the lamps it takes.

### Interface Description

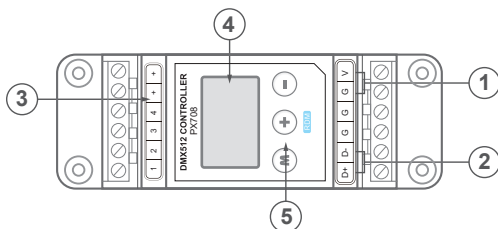

- (1) Power input interfac
- (2) DMX/RDM signal input/output interface
- (3) Driver output interface
- (4) Display LED
- (5) Keys for address setting

### Address setting keys:

1. The "ID" menu is used to set DMX address After entering the ID menu, the current DMX address is displayed. Press the "+" key for a short time and add one to the address. Press the key for a long time and the address will automatically increase upwards. "-" Key short press address minus one, long press this key address automatically decreases downward. Press the M key briefly to return to the superior menu.
2. The "AP" menu is used to set the output current of 4 channels. After entering the AP menu, the secondary menu "1" is displayed, representing 1 channel. Press the M key for a long time to enter the current gear menu of the tertiary menu, and the "+/-" key is used to set the current gear. Press the M key briefly to return to the secondary menu "1". If you want to set the current value of other channels, first jump to the specified channel with "+/-" keys in the secondary menu, and then enter the current setting menu of the current channel.
3. The "BIT" menu is used to set the number of digits of DMX channel. After entering the "bit" menu, use "+/-" keys to set whether the channel is 16bit or 8bit. press the m key briefly to return to the main menu.

### Driver output interface

Common anode, V+ and R,G,B,W interface can drive kinds of RGBW module or single-color module, Can regulate output current according to the actual load.

Remark: Connect the anode and RGBW wire of common anode RGBW module to the output interface of decoder directly; Connect the anode wire of single-color module to V+ on decoder, and connect the cathode wire to one of RGBW pin according to the LED's color; Connect several colors single-color module to one decoder, please connect their anode wires to V+ pin on decoder.

Wiring Diagram

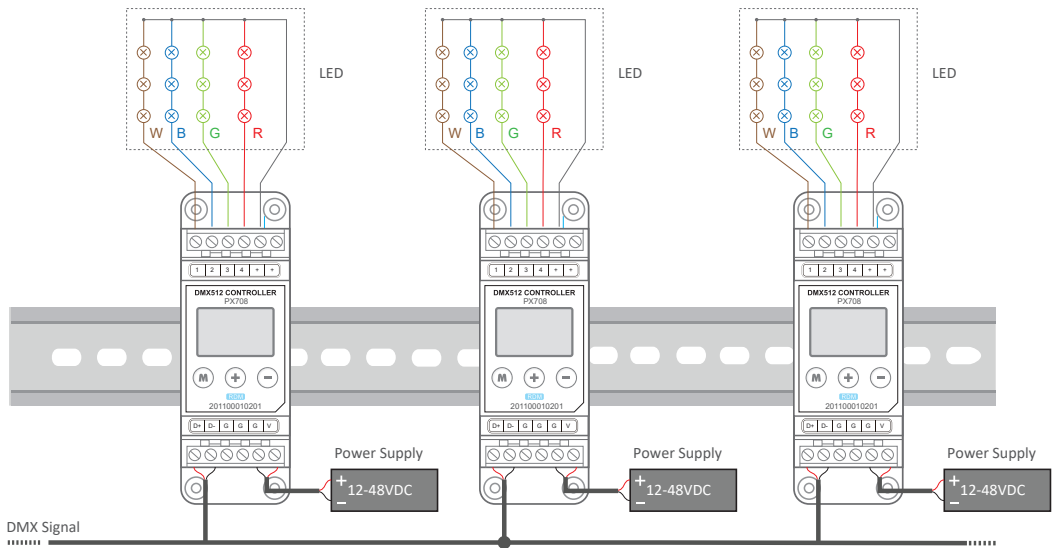

The wire for DMX is STP, the DMX signal has positive and negative signal. Pay attention to the polarity while soldering. Connect the positive signal, negative signal and GND to the corresponding signal of device.

Set DMX Address by button or scan and set automatically by DMX master controller followed RDM protocol.

Connect a signal terminal at the end of the whole connection.

**Installation Notes**

1. Input voltage must be fit the production work voltage
2. Do not overload
3. Installed in a ventilated and dry environment
4. Before commissioning of the power, should ensure that all wiring is correct before electricity.
5. If failure, do not secretly maintenance, please contact the supplier.

## PX708

### 产品特点

- 符合DMX512/1990, RDM2009国际标准协议
- 4通道输出, 每通道电流350/500/700mA可选
- 可通过按键, 灵活设置DMX地址
- 具有灯具颜色选择机制, 可控制1~4种基本颜色的灯具
- 为方便安装使用, 产品出厂时默认地址码设定为1

### 技术参数

通道	4通道
输入电压	12-48V DC
输出电压	1-42V DC
输出电流	350/500/700mA / 通道
输出功率	28W / 通道最大110W
保护	短路保护, 过流保护, 过温保护
尺寸	112(长)×35(宽)×67(高) mm
重量	90g
工作温度	-30 - 50 °C

### 接口介绍

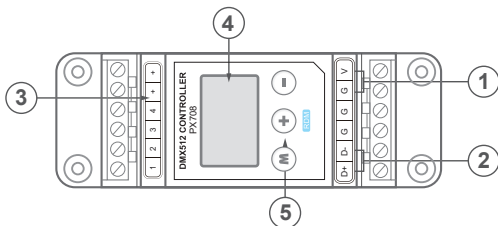

- (1) 供电输入端口
- (2) DMX/RDM信号输入/输出端口
- (3) 输出端口
- (4) LED数码管显示
- (5) 功能设定按键



### 产品尺寸

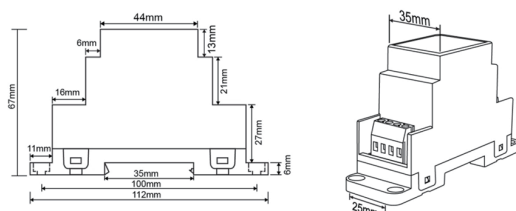

### 电源输入接口

直流12~48V输入, 为解码器本身和解码器所带灯具供电

### 按键功能设置

- 1、“ID”菜单, 用来设置DMX地址. 进入ID菜单后, 显示当前DMX地址, +键短按地址加一, 长按此键地址自动向上增加。-键短按地址减一, 长按此键地址自动向下减少。短按M键返回上级菜单。
- 2、“AP”菜单, 用来设置4通道的输出电流进入AP菜单后, 显示二级菜单“1”, 代表1通道, 长按M键进入三级菜单电流档位菜单, +/-键用来设置电流档位。短按M键返回二级菜单“1”。如果想设置其它通道电流值, 先在二级菜单中用+/-键跳转到指定通道, 然后再进入当前通道的电流设置菜单。
- 3、“bit”菜单, 用来设置DMX通道的位数进入“bit”菜单后, 用+/-键设置通道是16bit还是8bit.短按M键返回到主菜单。

### 驱动输出接口

共阳极驱动, 具有一个V+接口和4通道R,G,B,W输出接口, 可接各种全彩模组和单色模组

注: 共阳极连接的全彩模组可直接将正线和R,G,B,W控制线接至解码器的输出接口对应脚位上; 单色模组可将正线接至解码器的输出接口的V+脚上, 负线根据该模块的颜色接至解码器的输出接口R,G,B,W某一脚位上; 几种颜色的单色模组接到同一个解码器上, 须将它们的正线都接到解码器的输出接口的V+端口。

应用接线图

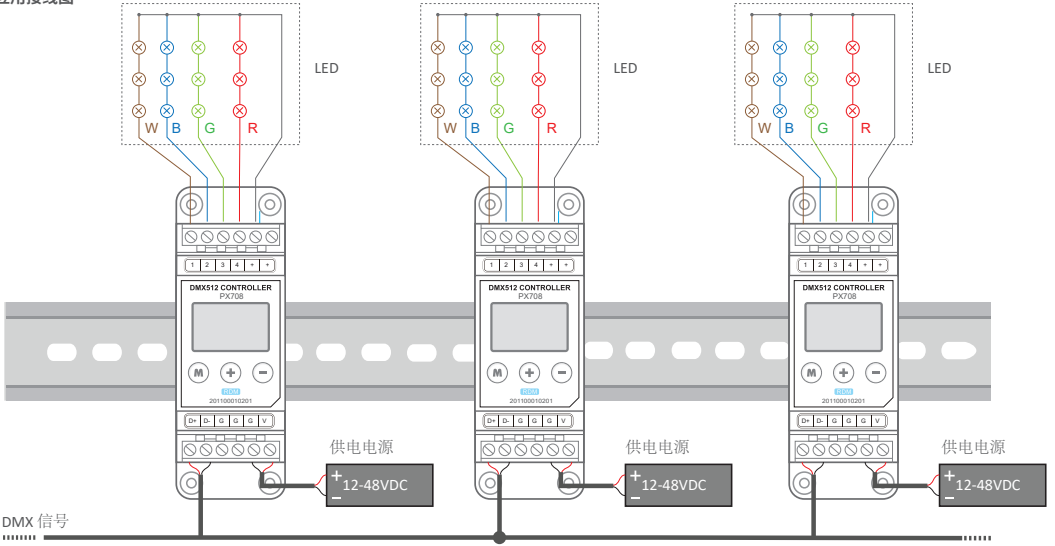

DMX接线为直连式，DMX信号有正信号和负信号。接线时，要注意极性。

将正信号，负信号和接地信号连接到设备相对应的接口。

通过按键来设置DMX地址，或者用遵循RDM协议的DMX主控来扫描并自动设置。

整个接线的尾部最后需接信号终结器。

### 安装注意事项

- 1、输入电压须在本控制器的规定工作电压范围内
- 2、不可超负荷使用
- 3、安装在通风干燥的环境中
- 4、通电调试前，应确保所有接线正确方可通电。
- 5、如果发生故障，请勿私自维修；如果有疑问，请联系供应商。